



### Application:

The SY actuators are NEMA 4X rated and designed to meet the needs of HVAC and Commercial applications. Offered on Belimo standard and high performance valve series, these actuators are available for on/off and modulating applications. Depending on the application, they are available in 24 VAC/VDC, 120 VAC and 230 VAC.

Technical Data	
Electrical connection	½" conduit connector, screw terminals
Motor protection	H Class insulation (SY-1), F Class (SY-2...5)
Gear train	high alloy steel gear sets, self locking
Operating range	(SY...-24) on/off, floating point (SY...24MFT) 2-10 VDC, 4-20mA, 0-10 VDC
Sensitivity	(SY...24MFT) 0.4mA/200mV
Reversal hysteresis	(SY...24MFT) 1.0mA/500mV
Feedback	(SY...24MFT) 2-10 VDC
Angle of rotation	90°
Direction of rotation	reversible
Position indication	top mounted domed indicator
Internal humidity control	resistive heating element
Auxiliary switches	(2) SPDT, 10A 250 VAC factory set for 5° and 85° change of state
Ambient temperature	-22°F to +150°F [-30°C to +65°C]
Humidity range	up to 95%
Housing type	IP67, NEMA 4X
Housing material	die cast aluminum alloy
Agency listings	ISO, CE, cCSAus

050904 - 02/12 - Subject to change. © Belimo Aircontrols (USA), Inc.

### Power Supply

24 VAC/VDC 50/60Hz, single phase

Model	Torque	Speed	Power Consumption	Duty Cycle		Override	Weight
				On/Off	MFT		
SY1-24(P)	35Nm/310 in-lbs	15s	1.8A	30%	75%	8mm Wrench	2.0kg/4.9 lb.
SY2-24(MFT)	90Nm/801 in-lbs	15s	3.0A	30%	75%	Hand Wheel	11kg/24.5 lb.
SY3-24(MFT)	150Nm/1335 in-lbs	22s	3.0A	30%	75%	Hand Wheel	11kg/24.5 lb.
SY4-24(MFT)	400Nm/3560 in-lbs	16s	6.0A	30%	75%	Hand Wheel	22kg/48.5 lb.
SY5-24(MFT)	500Nm/4450 in-lbs	22s	6.5A	30%	75%	Hand Wheel	22kg/48.5 lb.

# SY... Series Non-Spring Return Actuator Dimensions

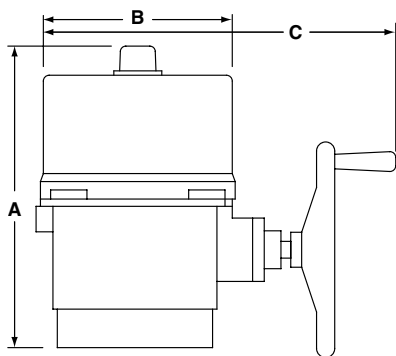
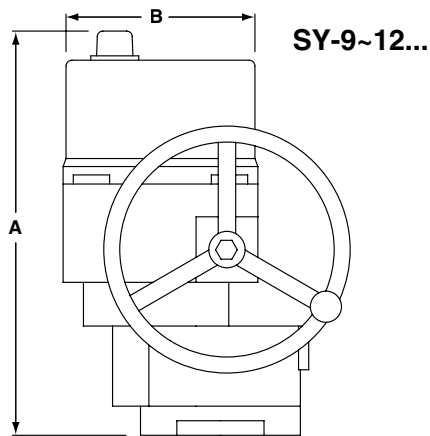
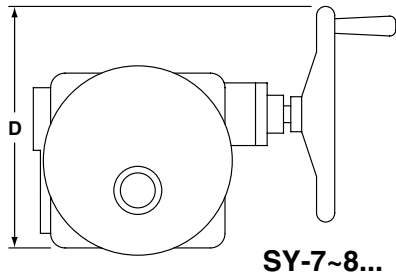
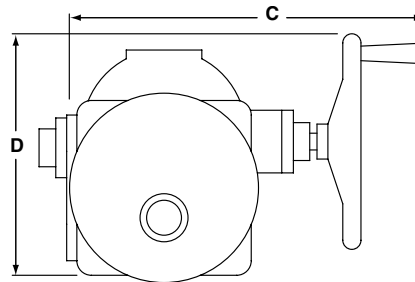
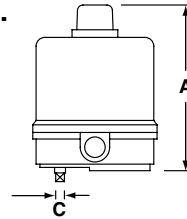
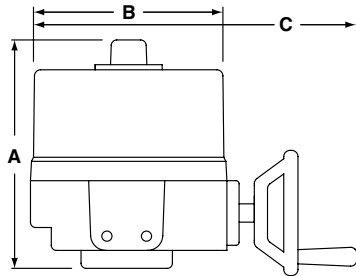
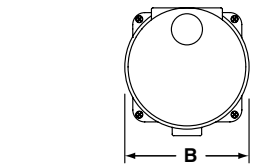
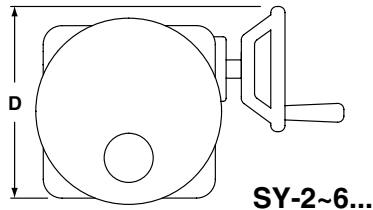

MODEL	DIM A (MAX)	Add to Dim A for cover removal	DIM B	DIM C (MAX)	DIM D
	Inches [mm]	Inches [mm]	Inches [mm]	Inches [mm]	Inches [mm]
SY1	6.10 [155]	3.94 [100]	4.25 [108]	8mm	-
SY2~3	10.04 [255]	7.48 [190]	7.87 [200]	12.99 [330]	7.87 [200]
SY4~6	12.40 [315]	8.86 [225]	9.21 [234]	14.96 [380]	11.81 [300]
SY7~8	16.54 [420]	8.86 [225]	9.21 [234]	17.72 [450]	13.39 [340]
SY9~12	23.23 [590]	8.86 [225]	10.24 [260]	18.50 [470]	13.78 [350]

Note: ~ indicates range of actuator i.e., SY2~3 = SY-2 and SY-3